

SPECIFICATIONS

DIAMETER:	10" (254.0 mm)
SENSITIVITY (2.83 V @ 1 m):	94 dB (IN-CAR @ 40 Hz)
POWER HANDLING:	350 W _{RMS} (1,400 W _{PEAK})
FREQUENCY RESPONSE:	18 ~ 150 Hz
NOMINAL IMPEDANCE:	4 OHMS
VOICE-COIL DIAMETER:	2.0" (50.8 mm)
DIMENSIONS:	

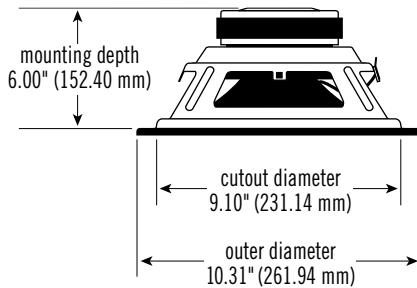

THIELE-SMALL PARAMETERS

VOICE COIL DC RESISTANCE:	R_{EVC} (OHMS)	4.11
VOICE COIL INDUCTANCE @ 1 kHz:	L_{EVC} (MH)	2.96
DRIVER RADIATING AREA:	S_D (IN ²)	53.40
	S_D (CM ²)	346.00
MOTOR FORCE FACTOR:	BL (TM)	16.64
COMPLIANCE VOLUME:	V_{AS} (FT ³)	1.36
	V_{AS} (LITERS)	32.13
SUSPENSION COMPLIANCE:	C_{MS} (µM/N)	189.00
MOVING MASS, AIR LOAD:	M_{MS} (GRAMS)	166.71
MOVING MASS, DIAPHRAGM:	M_{MD} (GRAMS)	163.01
FREE-AIR RESONANCE:	F_S (Hz)	28.35
MECHANICAL Q:	Q_{MS}	8.83
ELECTRICAL Q:	Q_{ES}	0.44
TOTAL Q:	Q_{TS}	0.42
MAGNETIC-GAP HEIGHT:	H_{AG} (IN)	0.39
	H_{AG} (MM)	9.80
VOICE-COIL HEIGHT:	H_{VC} (IN)	1.50
	H_{VC} (MM)	38.10
MAXIMUM EXCURSION:	X_{MAX} (IN)	0.56
	X_{MAX} (MM)	14.15

IMPEDANCE CURVE

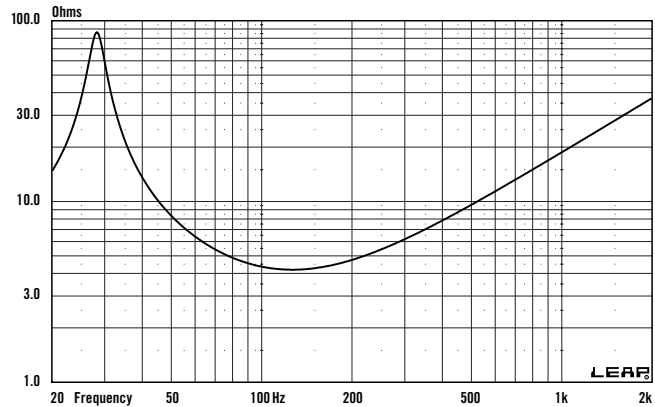

INFINITE Baffle FREQUENCY RESPONSE @ 2.83 V

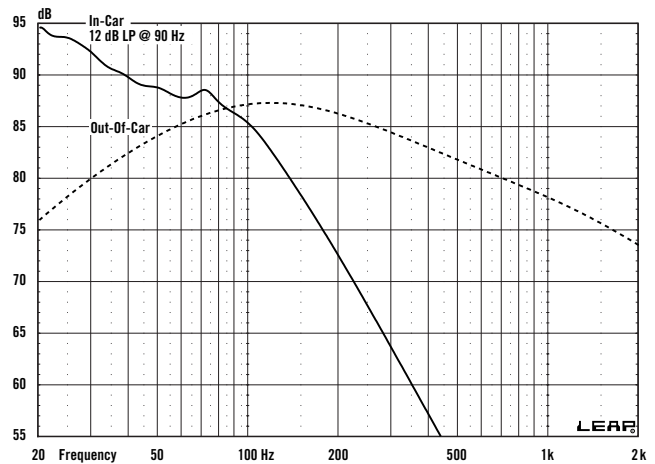

INFINITE Baffle EXCURSION/GROUP DELAY @ 250 W

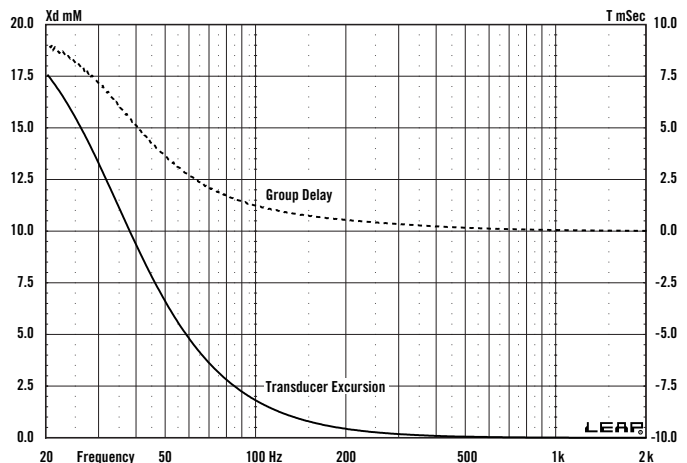

Infinity Kappa Perfect10 10" Woofer – Technical Data

SEALED BOX VOLUME



VENTED BOX VOLUME

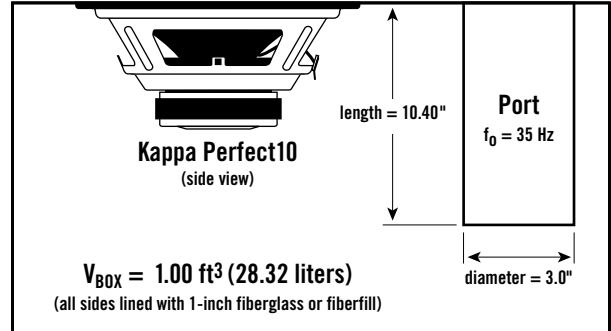

SEALED FREQUENCY RESPONSE @ 2.83 V

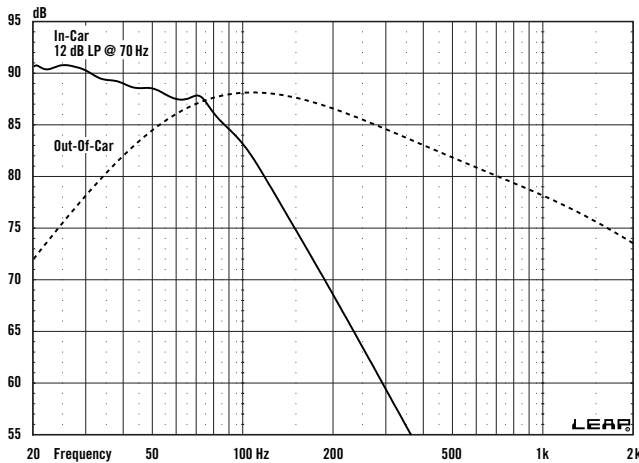

VENTED FREQUENCY RESPONSE @ 2.83 V

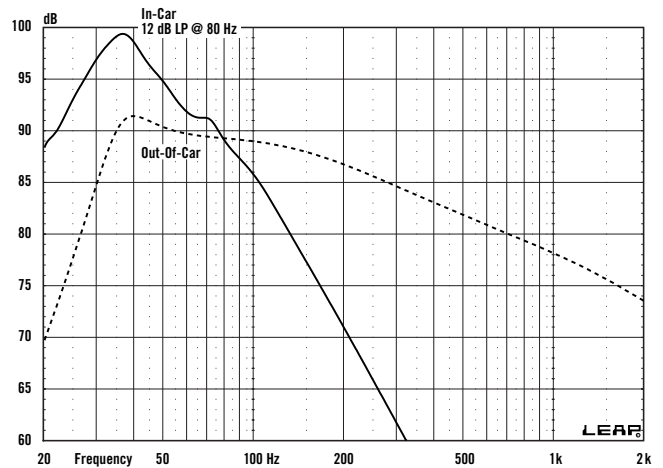

SEALED EXCURSION/GROUP DELAY @ 400 W

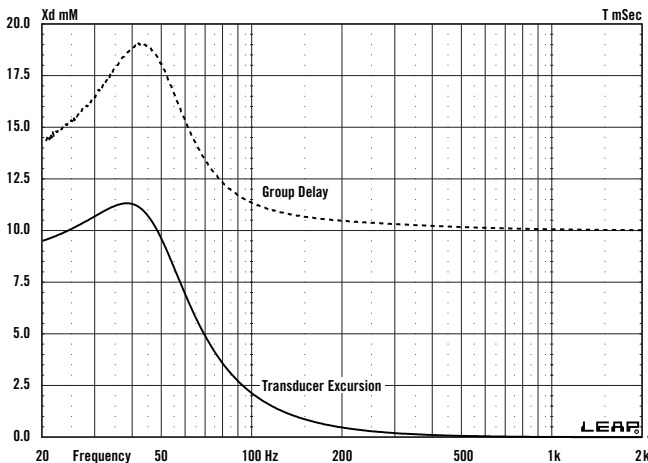

VENTED EXCURSION/GROUP DELAY @ 600 W

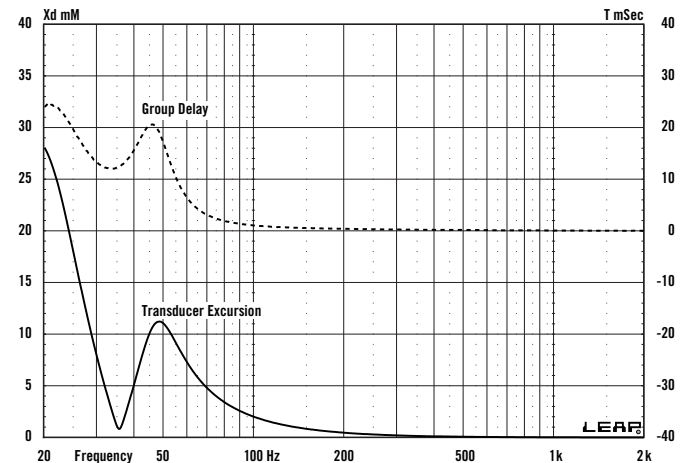

SEALED BANDPASS BOX VOLUME

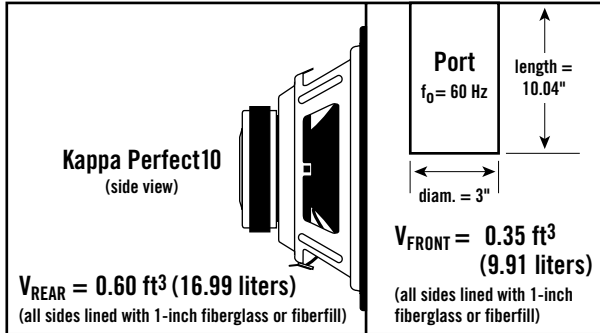

NOTES

SEALED BANDPASS FREQUENCY RESPONSE @ 2.83 V

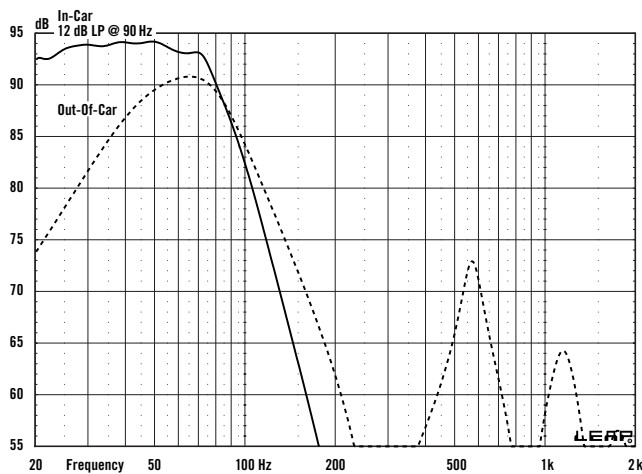

SEALED BANDPASS EXCURSION/GROUP DELAY @ 350 W

